







MOD. EVOX 7T

TECHNICAL FEATURES

Model	Performance		Capacity in Trays	Standard Tension	Power Consumption	Refrigerant
	(+90°C/+3°C)	(+90°C/-18°C)				
SQX7FT.30	30 kg	18 kg	7 GN 1/1 7 EN 60x40*	230V / 1Ph 50Hz	1,5 kW 8,5 A	R404A 0,900 kg
SQX7FT.30W						
SQX7FT.30R						
SQX7FT.30WR						
SQX7FT.30SG	/	/			0,3 kW 2,0 A	R404A 0,000 kg
SQX7FT.30SGCO ₂						CO ₂ 0,000 kg

* Pastry version is available for EN60x40 shelves only (es.:SQX7FT.30P).

CONSTRUCTIVE FEATURES

	Structure in stainless steel AISI 304 18/10 – External: Scotch Brite, interior: mirror finishing		Rounded inner and outer angles cleaning and space under the evaporator for a perfect and easy cleaning
	Certified Italian high performances refrigerating units		Oversized condensers to ensure reliability
	Special fans suitable for low temperature with speed regulation system		Cathaphoresis painted anti-corrosion evaporators

Structure insulation in CFC-free polyurethane DPO-0 ◆ **Door frame completely integrated in the structure itself to grant top hygiene** ◆ Self-closing door equipped with a silicone gasket resistant to low temperatures, magnetic and heated door frame ◆ **Core probe with strong silicone gum grip as standard** ◆ Lateral drain hole for condensation and water run out ◆ The technical room of evaporator and condenser can be easily inspected through a compass opening

The appliance is supplied without trays, without trolley, ramp and without mobile oven racks. CO₂ versions are supplied without thermic expansion valve. The manufacturer reserves the right to carry out modifications of the product without notice. For different voltages and/or frequencies quotations on demand.

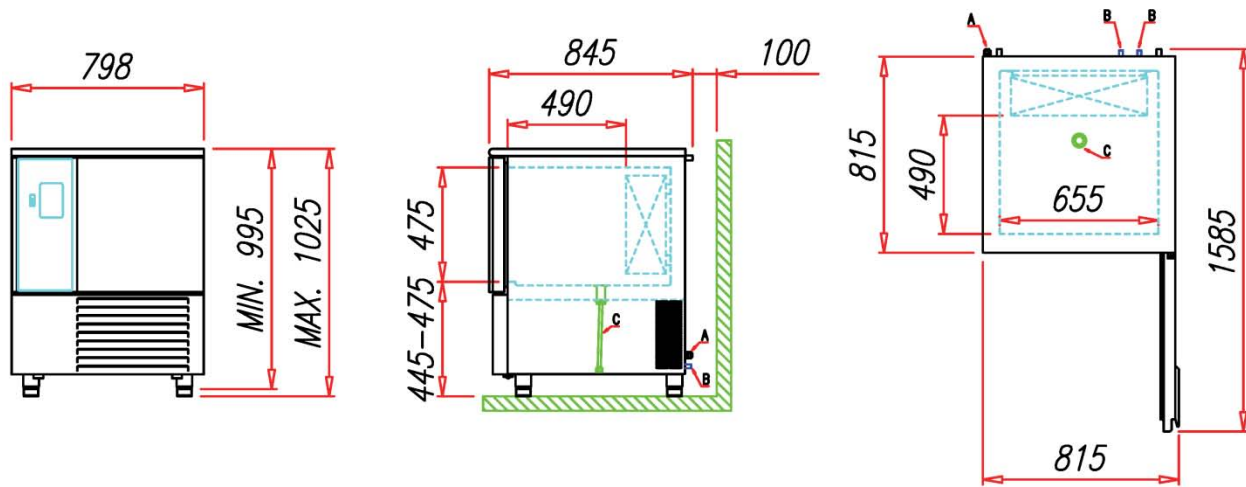

A = Electrical and Water connection (when needed)
 B = Refrigeration connection
 C = Evaporator water drain pipe

TECHNICAL DATA

Model	Refrigerating Power		Consumption kWh/kg		Net Weight	Insulation Thickness	Room Conditions	Certifications
	*Te = -10°C	*Te = -30°C	(+90°C/+3°C)	(+90°C/-18°C)				
SQX7FT.30	3.200 W	1.150 W	0,10	0,32	130 kg	70 mm	+32°C 60% UR	
SQX7FT.30W								
SQX7FT.30R								
SQX7FT.30WR								
SQX7FT.30SG								
SQX7FT.30SGCO ₂	/	/	/	/	95 kg			

* Te = Expansion Temperature – Condensation Temperature = +45°C

ELECTRONIC CONTROLLER

Cycles available:

- Temperature blast chilling and conservation
- Time blast chilling and conservation
- Temperature deep freezing and conservation
- Time deep freezing and conservation
- Soft and hard cycles for both blast chilling and deep freezing
- Multi timer non-stop cycle
- Pre-cooling

Optional cycles:

- Multi core probe non-stop cycle
- Sterilization
- Leavening/proving
- Low temperature slow cooking



Special functions:







- Recipe book
- Automatic control on core probe insertion
- raw fish sanitation
- Thawing
- Manual defrost
- Special cycle for ice cream
- Drying
- Evaporator fan speed regulation
- USB

Optional functions:

- Core probe heating
- Multipoint core probe
- Multi core probe

The appliance is supplied without trays, without trolley, ramp and without mobile oven racks. CO₂ versions are supplied without thermic expansion valve. The manufacturer reserves the right to carry out modifications of the product without notice. For different voltages and/or frequencies quotations on demand.

ACCESSORIES (OPTIONAL)

	Leavening and Slow cooking	ACC FO2		Led light	ACC 147
	Ramp (1 piece)	ACC 140		Left opening door	ACC 135
	Ozone Sterilizer	ACC 110		Heated Core Probe	ACC 509
	Multipoint core probe	ACC 510			

DATA SHEET ACCORDING TO prEN 17032

Model	Product Type	Refrigerating Gas			Program	
		Type	GWP	Charge	Blast Chilling	Deep Freezing
SQX7FT.30	BLAST CHILLER DEEP FREEZER	R404A	3922	0,900 kg	HARD	TIME
SQX7FT.30W						
SQX7FT.30R						
SQX7FT.30WR						
SQX7FT.30SG		CO ₂	1	0,000 kg	/	/
SQX7FT.30SGCO ₂						

Model	Blast Chilling (+65°C / +10°C)			Deep Freezing (+65°C / -18°C)		
	Maximum Capacity	Energy Consumption E	Time t	Maximum Capacity	Energy Consumption E	Time t
SQX7FT.30	30 kg	0,10 kWh/kg	120 min.	18 kg	0,32 kWh/kg	260 min.
SQX7FT.30W						
SQX7FT.30R						
SQX7FT.30WR						
SQX7FT.30SG	/	/	/	/	/	/
SQX7FT.30SGCO ₂	/	/	/	/	/	/

Manufacturer: A.T.O. S.R.L. - Via dell'Artigianato, 24 - 31030 Castello di Godego - Treviso – Italy

STANDARD PACKAGE

Package	External Dimensions			m ³	Gross Weight	
	Width	Depth	Height		Standard	SG Version
1	890 mm	950 mm	1210 mm	1,02	155 kg	120 kg

The appliance is supplied without trays, without trolley, ramp and without mobile oven racks. CO₂ versions are supplied without thermic expansion valve. The manufacturer reserves the right to carry out modifications of the product without notice. For different voltages and/or frequencies quotations on demand.